



View with chemical drum Olin HTH 40 kg

Table of contents

A: Dosing system

- A1 Dosing technic chlorine d25 (till 08.1992)
- A2 Dosing technic chlorine PLG (since 09.1992)

B: Dosing head/ hopper

- B1 Dosing head for sheet metal drum
- B2 Dosing head for plastic drum (since 10.1999)

C: Pre filter

- C1 Pre filter d75

D: Venturi with suction tube

- D1 Venturi with suction tube 3/8" (till 09.1999)
- D2 Venturi with suction tube 1/2" (since 10.1999)

E: Acid dosing system

- E1 Acid dosing system SR25 (till end 2001)
- E2 Acid dosing system Sa (since 2002)

F: Floating valve

- F1 Floating valve CfG (till end1991)
- F2 Floating valve d25 (since 1992)

G: Flushing tank

- G1 Flushing tank PVC (till 09.1999)
- G2 Flushing tank PE (since 10.1999)

H: Control system

- H1 Control system H DOS
- H2 Control system MCU DOS (till 03.1992)
- H3 Control system MCU 1a (04.1992- 11.1993)
- H4 Control system MCU 1b (12.1993- 03.1999)
- H5 Control system MCU 1C (since 04.1999)
- H6 Control system S1 (03.2001- 06.2001)
- H7 Control system S3 (since 07.2001)

I: Booster pump

- I1 Booster pump Calpeda (till 03.1999)
- I2 Booster pump Lowara (since 04.1999)

J: Drum carrier

- J1 Drum carrier GR 45

A2 Dosing technic chlorine PLG

| | |
|---|---|
|  <p>motor holder GR PLG d25 (for screw D19) Art. 11541</p> |  <p>motor holder GR PLG d32 (for screw D26) Art. 11542</p> |
|  <p>dosing screw GR d6/D19/L120 mm Art. 11549</p> |  <p>dosing screw GR d6/D26/L130 mm Art. 11550</p> |
|  <p>dosing motor PLG 30-35 rpm - cable 0,6m for Granudos 45 Art. 11676</p> |  <p>dosing motor PLG 30-60 rpm - cable 0,6m for Granudos 100 Art. 11546</p> |
|  <p>Set of seal to screw/motor PLG Art. 11554</p> |  <p>dosing nozzle heated GR 45/100 Art. 11556</p> |

B2 Dosing head / hopper



Dosing head complete with:
 hopper, cover, dosing unit GR45, chlorine empty switch

| | | |
|-------------------|-------|------------|
| Olin HTH | 45 kg | Art. 11521 |
| Olin HTH | 40 kg | Art. 11522 |
| Melchemie | 50 kg | Art. 11523 |
| Pittclor | 45 kg | Art. 11524 |
| Hansa Chemie / HC | 50 kg | Art. 12316 |



Dosing hopper GR45

| | | |
|-------------------|-------|------------|
| Olin HTH | 45 kg | Art. 11526 |
| Olin HTH | 40 kg | Art. 11527 |
| Melchemie | 50 kg | Art. 11529 |
| Pittclor | 45 kg | Art. 11528 |
| Hansa Chemie / HC | 50 kg | Art. 12315 |



Cover for hopper GR
 without knocker Art. 11530
 with knocker Art. 12866



Knocker complete without control plate
 Art. 11558

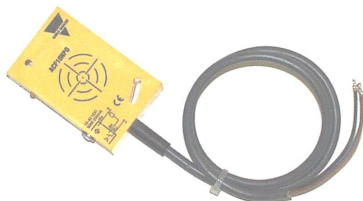

Empty switch cap.
 GR45/ 100/ PAK
 Art. 10337

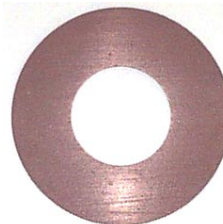



Seal washer 60/30 mm red
 dosing nozzle – cover
 Art. 11099

C1 Pre filter d75

| | |
|--|---|
|  <p>Filter d75 complete Art. 12745</p> |  <p>O- Ring for filter d75 Art. 11258</p>  <p>Filter housing d75 GR Art. 12746</p> |
|  <p>Filter top d75 Art. 12304</p> |  <p>Filter insert SS d75 Art. 11640</p> |



D2 Venturi with suction tube 1/2"

| | |
|---|---|
|  <p>Venturi complete GR/ PAK 1/2" Art. 11792</p> |  <p>Venturi body GR/ PAK 1/2" Art. 12305</p> |
|  <p>Venturi diffusor nozzle GR/ PAK 1/2" Art. 12306</p> |  <p>washers set for diffusor nozzle: 5,5 – 6 – 7 Art. 11594</p> |
|  <p>Flow switch holder GR 1/2" S14 Art. 11599</p> |  <p>Switch bobbin ind. 1/2" Art. 11606</p> <p>30 mm</p>  <p>Seal ring Vi14/9 for switch bobbin 1/2" Art. 11090</p> |
|  <p>flow switch ind. M18x 1 Art. 11603</p> | |

E1 Acid dosing system SR25 (till end 2001)

| | |
|--|--|
|  <p>Acid pump SR25/ 80 complete Art. 11627</p> |  <p>Gear motor SR25 – 80 Up/m Art. 11877</p> |
|  <p>Pump housing SR25 Art. 11488</p> |   <p>Roller SR25 Art. 10038</p> <p>guide band SR25 Art. 10026</p> |
|  <p>Suction carboy lance GR45 d16x 500mm Art. 12523</p> |  <p>Dosing hose complete SR25 4.8 x 1.6N Art. 11852</p> |
|  <p>Acid injection valve 1 KF-3/8" Art. 11633</p> |  <p>repair set for acid injection valve 1 KF-3/8" Art. 11636</p> |

E2 Acid dosing system Sa

| | |
|--|---|
|  <p>Acid dosing pump Sa complete Art. 11628</p> |  <p>Gear motor for acid pump Sa Art. 12705</p> |
|   <p>Tube holder Sa Art. 12703</p>  <p>Pump housing Sa Art. 12702</p> |  <p>Roller Sa Art. 12609</p>  <p>safety disc Sa Art. 12704</p> |
|  <p>suction carboy lance GR 45 d16x 500mm Art. 12523</p> |  <p>Dosing tube Sa 4.8 x 1.6 x 137mm Art. 12608</p> |
|  <p>Acid injection valve 1 KF-3/8" Art. 11633</p> |  <p>repair set for acid injection valve 1 KF-3/8" Art. 11636</p> |

F2 Floating valve d25

| | |
|---|--|
|  <p>floating valve d25 complete Art. 11617</p> |  <p>floater for floating valve Art. 11621</p> |
|  <p>Valve body for floating valve d25 GR 10- 100 Art. 11624</p> |  <p>Piston holder floating valve d25 Art. 11622</p> |
|  <p>Membrane for floating valve d25 Art. 11619</p> |  <p>O-ring 3,68x1,78Vi Art. 11255</p> <p>valve cone with O-ring and piston Art. 11284</p> |
|  <p>Elbow to floating valve 3/8" – 6x1 Art. 11616</p> | |

G2 Flushing tank PE



Tank PE with mounting angles GR 45/100-6
 Art. 11562



flushing tube GR 45/100-6
 Art. 11564



dust protection tube
 Art. 11561



Level switch tank GR/PAK 0,6 m
 Art. 10496

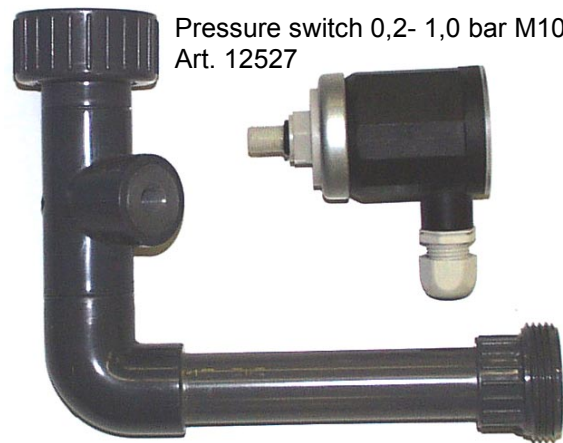

Pressure switch 0,2- 1,0 bar M10 x1mm
 Art. 12527

fitting filter - pump with pressure switch fitting M10x1
 GR 45/100-6
 Art. 12307

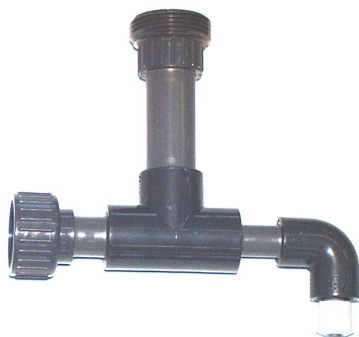

Distribution -T
 booster pump-Lo GR
 45/100-6
 Art. 11589

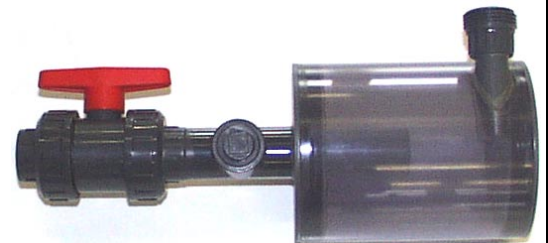

Mixing cyclone GR 45/100-6
 Art. 11612



Connecting elbow
 Venturi to cyclone GR 45/100-6
 Art. 12308

H5 Control system MCU

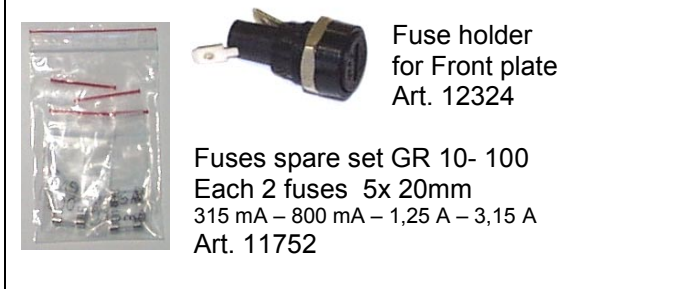
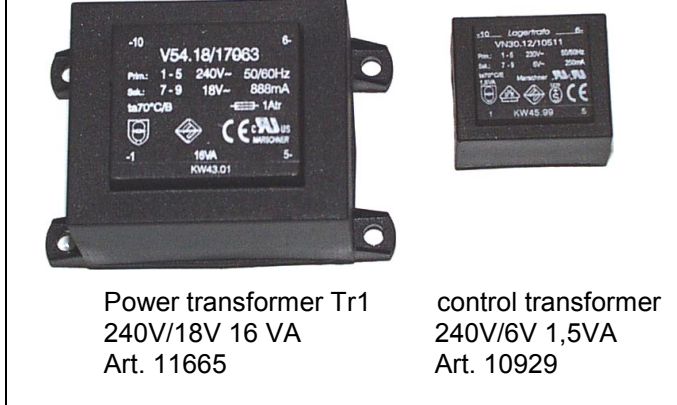
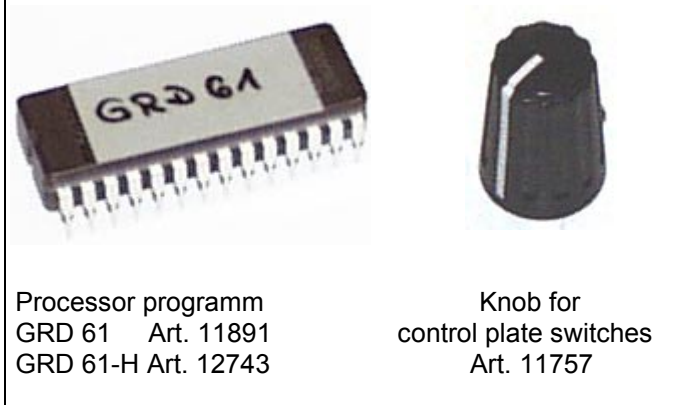
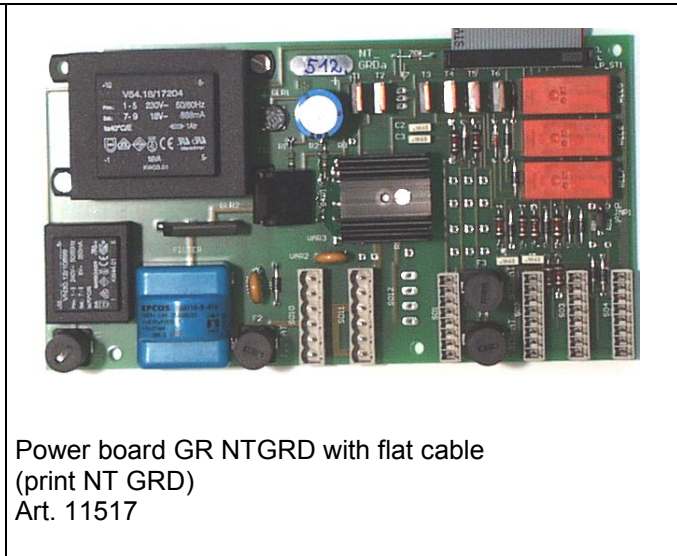
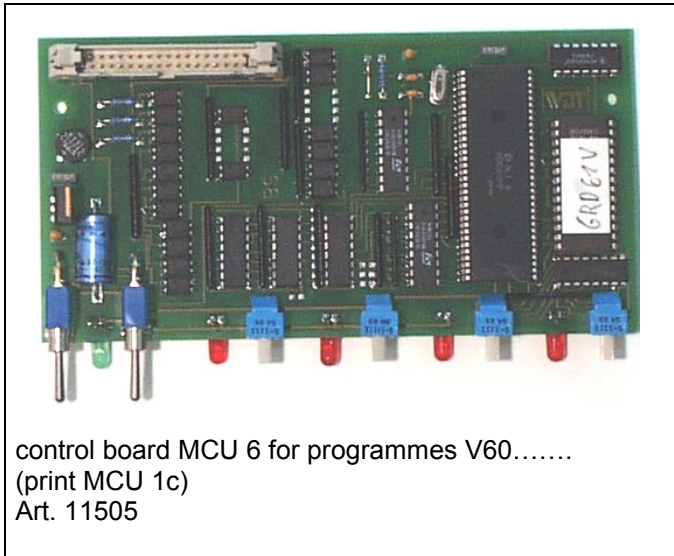

H7 Control system S3

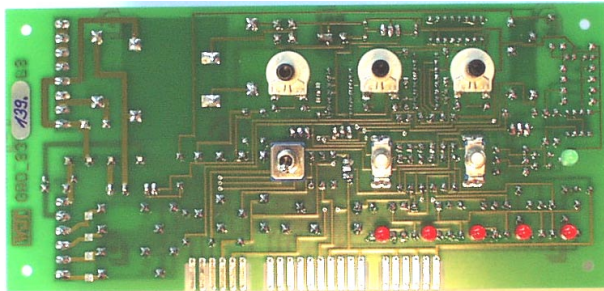

Control board GRD_S3 – front view
 Art. 12335

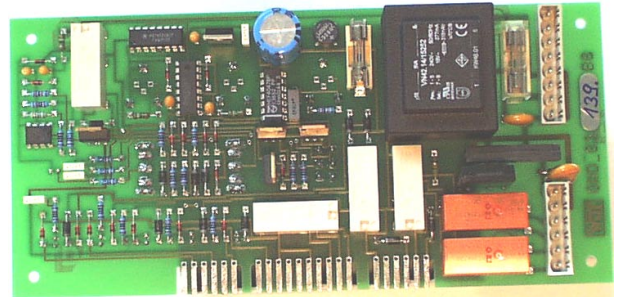

Control board GRD_S3 – view from back
 Art. 12335



Knob for control plate S3
 Art. 11031



Power transformer
 240V/18V 5 VA
 Art. 10924



Cover for control box GR45 Art. 12600
 Hinge control housing Art. 10965



locker plexi for control box GR45
 Art. 11512



Fuse holder
 for Front plate
 Art. 12324

Fuses spare set GR 10- 100
 Each 2 fuses 5x 20mm
 315 mA – 800 mA – 1,25 A – 3,15 A
 Art. 11752



Main switch GR/ PAK
 Art. 11338

I1 Booster pump Calpeda



booster pump Calpeda NTM 61
 new Art. 10332
 exchange Art. 11567

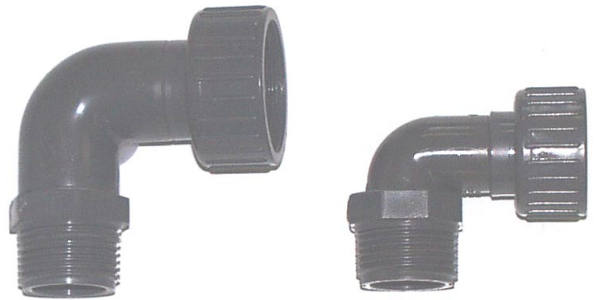

Pump connector fitting NTM 61
 Suction side 1" -d25 Art. 11577
 Pressure side 1" -d20 Art. 11576

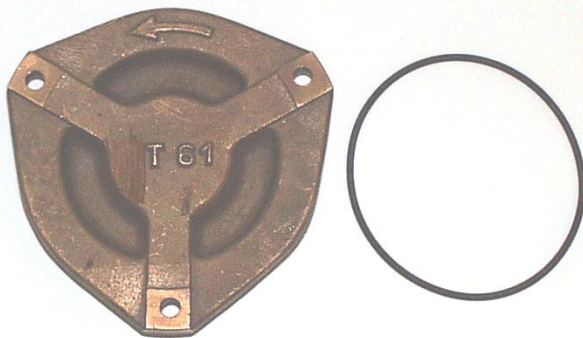

pump end plate NTM 61
 Art. 10330

O- ring pump end plate
 Art. 11578



impeller NTM 61 SS
 Art. 10336



key way for
 impeller
 Art. 10335

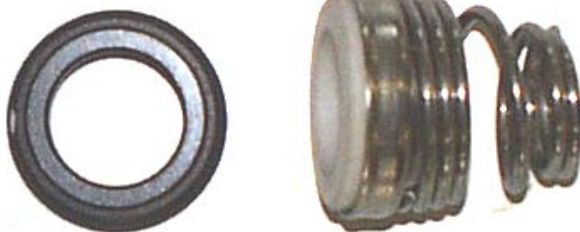

slide ring seal NTM 61 complete Art. 10333



condenser
 for NTM 61
 10µF
 Al housing
 Art. 10329



condenser
 for NTM 61
 10µF
 Art. 11579

I2 Booster pump Lowara

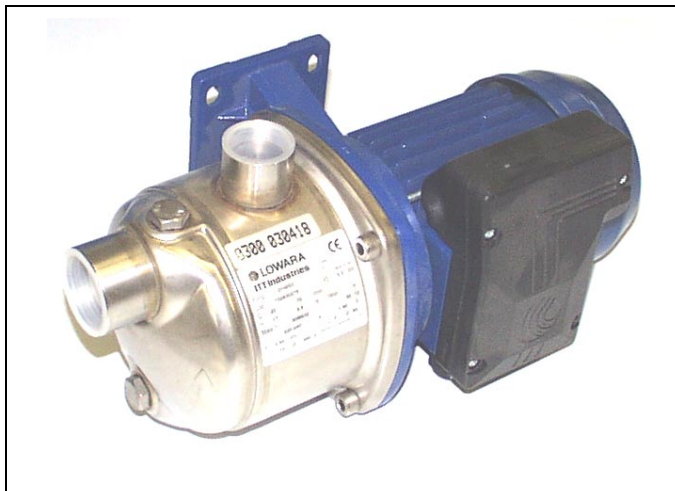

booster pump Lo 2HMS3 **90°** (04.1999 – 09.1999)
 from 04/99 to 09/99
 Art. 11568



booster pump Lo 2HMS3 (since 10.1999)
 Art. 10657



Slide ring seal Lowara
 2HMS3
 Art. 10660 till end 2001
 Art. 12800 since 2002 type A

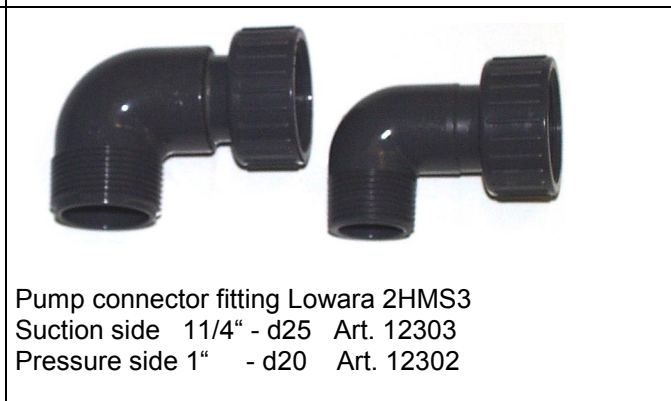

Pump connector fitting Lowara 2HMS3
 Suction side 1 1/4" - d25 Art. 12303
 Pressure side 1" - d20 Art. 12302

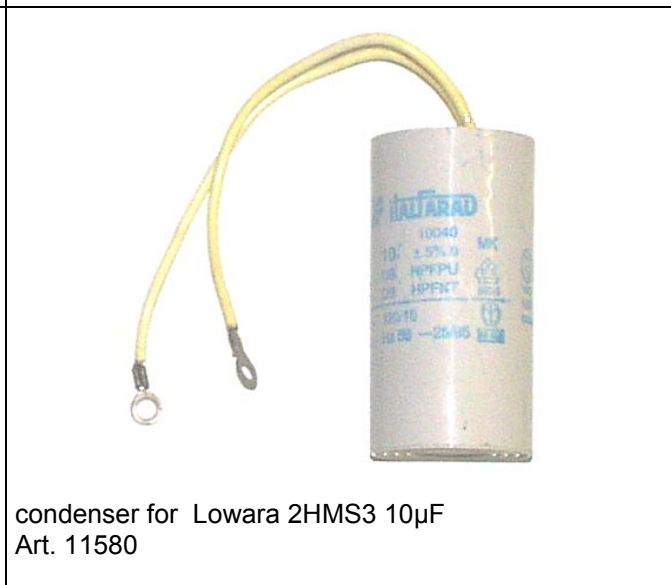
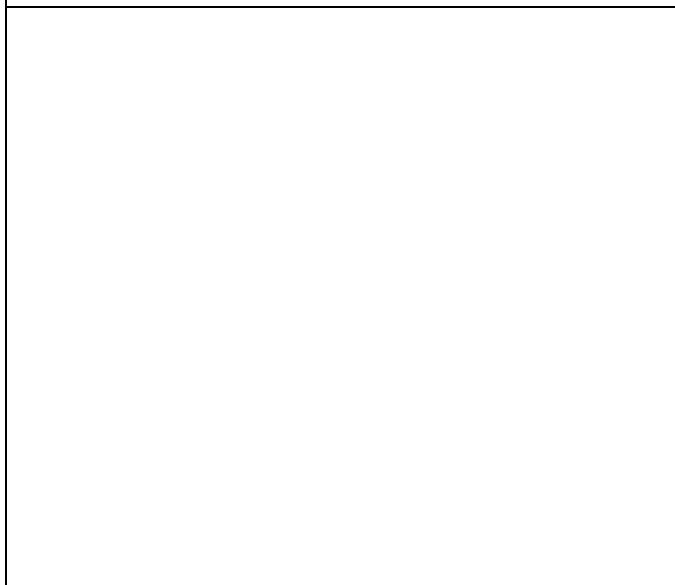

condenser for Lowara 2HMS3 10µF
 Art. 11580

J1 Drum carrier GR 45

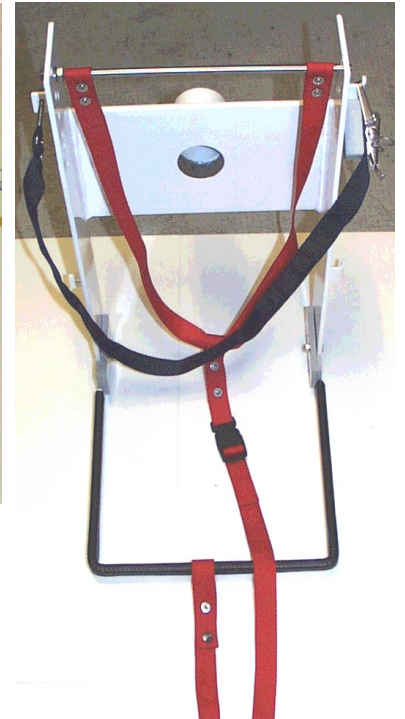

view to drum carrier with safety belt and band clamps GR 45/100



Safety belt GR 45/100
 Olin HTH 40 kg, HC 50 kg Art. 11501
 Olin HTH 45 kg, PITT 45 kg, MC 50 kg Art. 12327



Band clamp for GR 45/100/PAK
 Art. 11500



rod for chlorine drum 280x8 mm
 Art. 11508



Edge protection for carrier
 Art. 11509